

# TAKEX

# FLAME SENSOR

## FS-2000E



### Instruction Manual

We appreciate your purchase of a TAKEX flame sensor. This sensor will provide long and dependable service when properly installed. Please read this Instruction Manual carefully for correct and effective use.

Please Note : This sensor is designed to detect flames and to initiate an alarm ; it is not a fire-preventing device.

TAKEX is not responsible for damage, injury or losses caused by accident, theft, Acts of God (including inductive surge by lightning), abuse, misuse, abnormal usage, faulty installation or improper maintenance.

### PRODUCT DESCRIPTION

Flame sensor FS-2000E is designed to detect ultraviolet rays contained in flames, and to initiate an alarm.

In addition to alarm sound, FS-2000E is equipped with form C (N/C, N/O) output, to meet professional application.

Also, memory LED enables you to find out the initiated sensor out of a series of sensors.

Area adjustment mechanism brings wide selection of protection angle.

Quick separation of sensor and base eases installation and maintenance.

## 1 PARTS DESCRIPTION

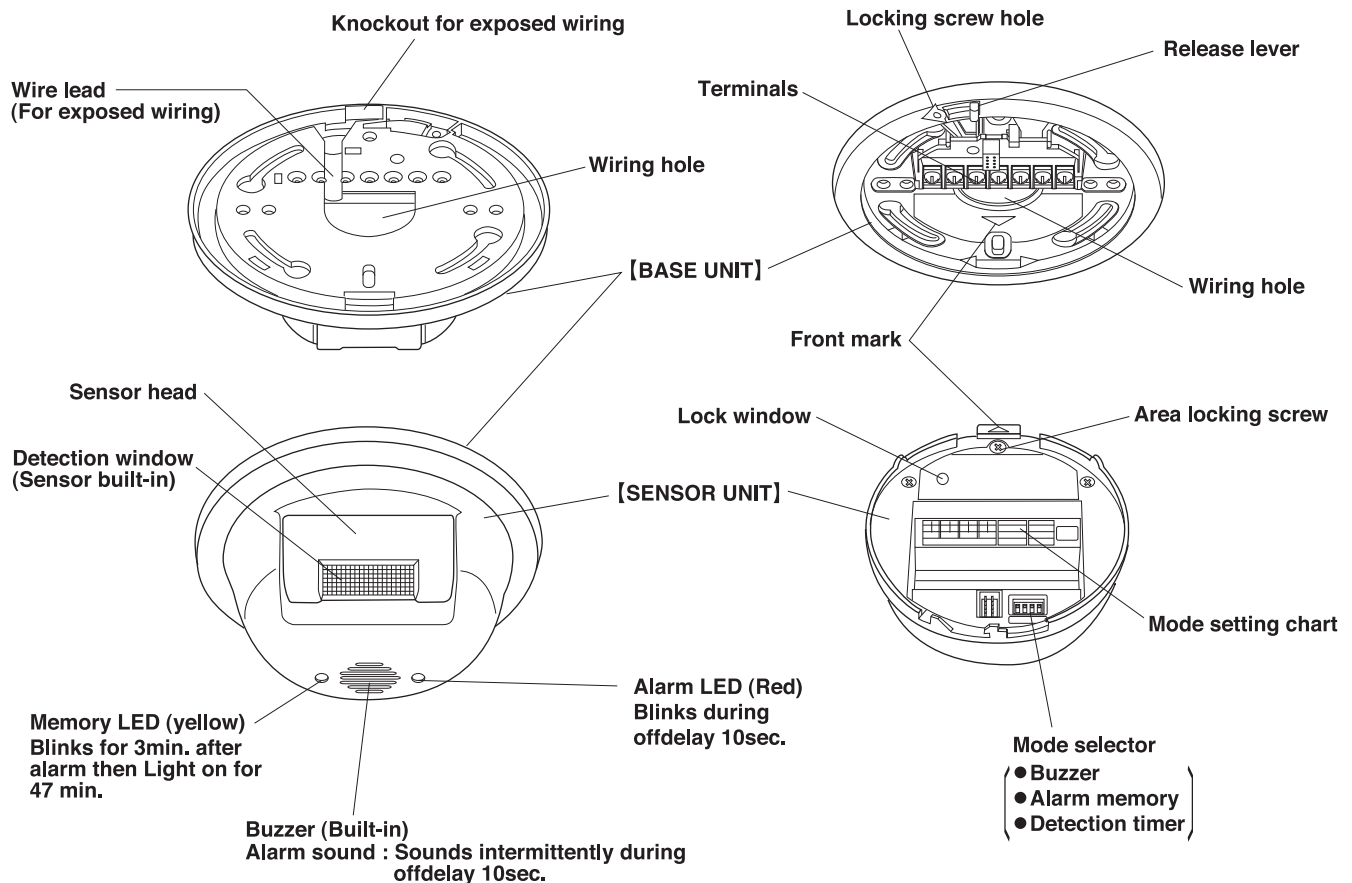

#### ACCESSORY



Sensor locking screw  
φ 3×6 (1 pce.)



Tapping screw  
φ 4×25 (2 pcs.)

# 2 ATTENTION

## Product classification

This sensor is designed to detect ultraviolet rays contained in flames, and to issue a signal.

This unit is neither fire detector nor heat detector nor smoke detector.

TAKEX is not responsible for damage, injury or losses by fire, accident, calamity, Acts of God (including inductive surge by lightning), abuse, misuse, abnormal usage, faulty installation or improper maintenance.

## Others

●When an strong impact is given to the sensor, it may cause damage, malfunction or less performance. Do not handle in a rough manner.

●Intense flames such like gas explosion's may damage the sensor, instead of the detection.

## Objects to be detected

This sensor detects ultraviolet rays contained in flames.

Therefore, this sensor may detect something including ultraviolet rays but not in flame. Besides, this sensor does not detect the burning object which is not flaming.

Possible cause of false alarm Do not install the sensor nearby the followings.	Flames which can not be detected.
<ul style="list-style-type: none"> <li>●Halogen lamp</li> <li>●Electric discharging lamp such like mercury lamp</li> <li>●Electric sterilizer lamp</li> <li>●Spark of welding</li> <li>●Electric spark (caused by motor, pantograph)</li> <li>●Sunlight</li> <li>●Electric discharge of thunderbolt</li> <li>●High electric field</li> <li>●All the objects which emanates ultraviolet rays</li> </ul>	<ul style="list-style-type: none"> <li>●Flames through the glass or transparent resin</li> <li>●Lighting portion of cigarette</li> <li>●Burning charcoal or briquet</li> <li>●Electric stove</li> <li>●Burnig object without flames</li> </ul>

# 3 DO'S AND DON'T'S

○ According to the detection area chart and operation check, decide installtion place not to form the death angle.

○ Do not install in the following places.

●Do not install in a site which is subject to direct or reflecting sunlight and rain. (This sensor is for indoor use only)

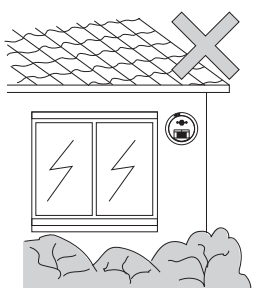

●Do not install in high humid place such like bathroom.

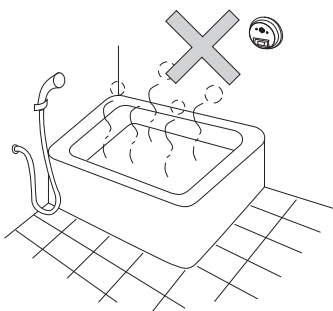

●Do not install in a site where fire (flame) is usually used such like kitchen.

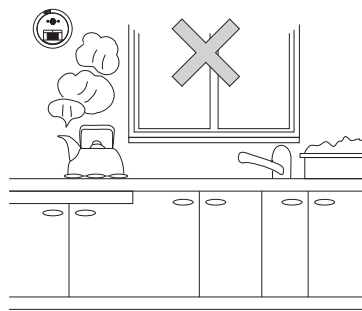

●Do not install in front of the object to intercept light. (including glass and transparent resin etc.)

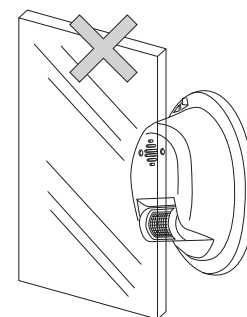

●Do not install in a site where the temperature falls less than +14°F (-10°C) or rises more than +140°F (+60°C).

●Do not give an impact to sensor. it may cause damage, malfunction and less performance to the sensor.

●Do not put water to the sensor, or leave the sensor in humid place. It may cause malfunction.

●This sensor's alarm output is 2 sec. offdelay, and alarm sound / LED is 10 sec. offdelay action.

By detecting a flame, the alarm will be initiated after the set time of timer passed.

The alarm action continues during the fire, and stops 2 sec. and 10 sec. later each after the extinction.

(Alarm sound : intermittently LED : continous)

\*when alarm sound is "OFF", it does not sound.

# 4 WIRING

## Terminal arrangement

### Power

10V to 30VDC  
(non-polarity)  
Stand-by : 25mA  
Alarm : 75mA Max. (buzzer : ON)  
40mA Max. (buzzer : OFF)

### Alarm output

Dry contact relay output Form C  
Action : Offdelay (detection time + 2 sec.)  
Capacity : 30VDC · 0.3A or less  
(protective resistance 3.3 ohms)

### Tamper

Dry contact output N.C.  
Action : Open when sensor unit is detached  
Capacity : 30VDC · 0.25A or less

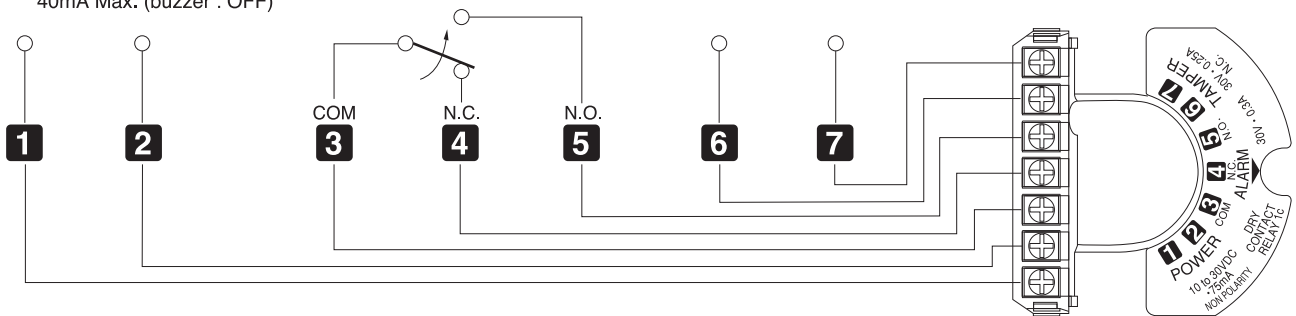

## Basic connection

[2 units connection in series (N.C.)]

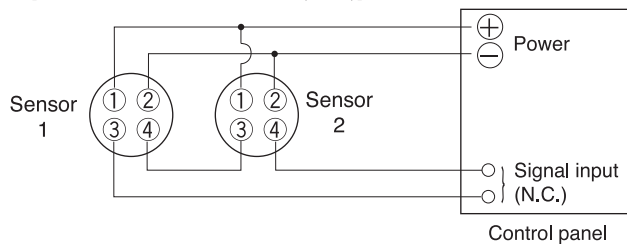

## [Allowable wiring distance between sensor and power source]

Size of wire used	Distance at 12VDC
AWG 22 (Dia. 0.65mm)	490 ft. (150m)
AWG 20 (Dia. 0.80mm)	820 ft. (250m)
AWG 18 (Dia. 1.00mm)	1,230 ft. (375m)

- Note 1) The maximum wire length, when two or more units are connected, is the above distance divided by the number of units.  
2) The protection circuit can be wired to a distance of 3,280 ft (1,000m) with AWG 22 (0.65mm dia.) wire.

# 5 INSTALLATION

- 1) Locate the installation site.  
(Ref : 3, DO'S AND DON'T'S and 7, DETECTION AREA)
- 2) Slide the release lever to detach the sensor unit.

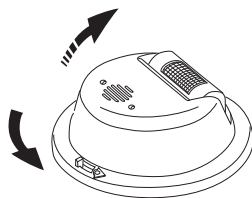

- 3) Fix the base with the screws included.  
(Ref : Base installation described later)

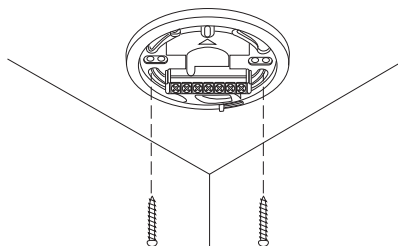

※To make the exposed wiring, break the knockout and insert wires into the wire lead.

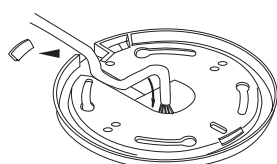

- 4) Connect wire to terminals of the base.  
(Ref : 4, WIRING)
- 5) Make the set-up of detection timer, alarm sound and alarm memory.  
(Ref : 6-(2) Function setting)
- 6) Attach the sensor unit to base unit.

- (1) Turn front marks of base unit and sensor unit point same directions.

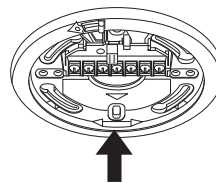

- (2) Insert sensor unit into base unit.

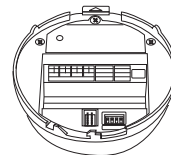

- (3) Push sensor unit until release lever is locked.



- 7) Check operation and area.

※Sensor head can be adjusted ahead with 4 steps. (Ref : 7, Detection area)

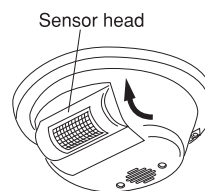

- 8) Detach sensor unit, and turn Area locking screw to right and fix sensor head tightly.

(All the inside of lock window have to be turned into black.)

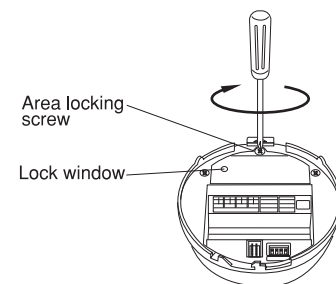

- 9) Attach sensor unit on base unit.

●When sensor unit is detached, wrap it in palm and slide release lever.



●To lock sensor unit, insert sensor locking screw into locking screw hole and tighten it.

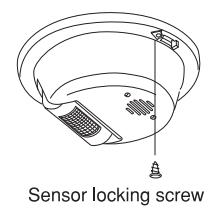

**[Installation of base]** ● Installation hole This product is equipped with installation holes (pitch 3.29" or 83.5mm) to make installation easy and the sensor's direction adjustable.

**Installation hole**

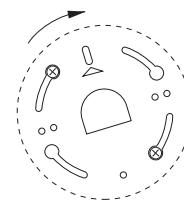
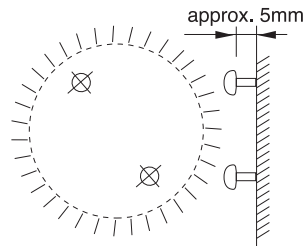
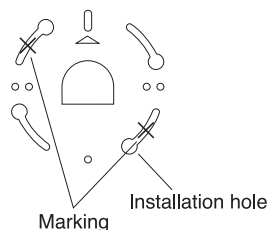

- (1) Place the base on the site and mark X on 2 points 180° apart.
- (2) Thrust the 2 pcs. of tapping screws (accessory) leaving 5mm exposed from the surface.
- (3) Adjust the sensor's direction by turning the base. (adjustment range 25°)
- (4) Tighten the screws.

# 6 OPERATION AND FUNCTION

## (1) Operation

### Alarm (Basic action)

This product alarms only by detecting the flame continuing for the set time of detection timer.

(0.2sec., 1sec., 6sec. and 30sec.)

( Buzzer : Sounds intermittently every 0.2sec.  
LED : Lights on  
Alarm output : Continuous )

When the flame continues further, the above alarm actions are also continued for the meantime. 2sec. after the flame goes out, alarm output stops, and 10sec. after, alarm sound and LED stop (off delay). Then sensor goes back to armed mode.

## (2) Mode setting

FS-2000E is equipped with 3 functions which can be used according to the application or environment. Mode setting will be done by mode selector (dip switch) in accordance with mode setting chart on the back side of sensor unit.

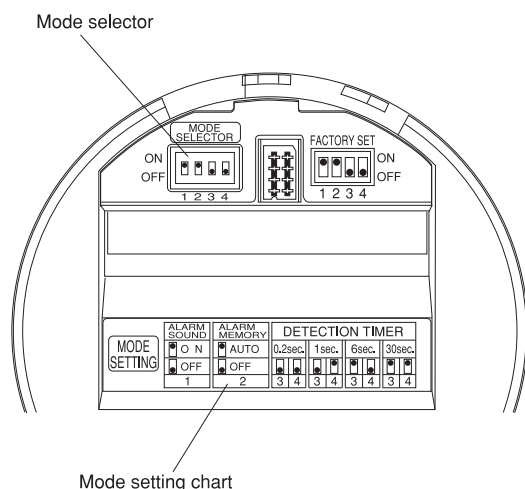

### Alarm sound (buzzer) Selector No.1

Buzzer can be off by mode selector No.1, when external output is used.

Setting	Buzzer
<input checked="" type="checkbox"/> ON 1	YES
<input type="checkbox"/> OFF 1	NO

### Alarm memory Selector No.2

When 2 or more sensor are connected on 1 loop, which sensor is initiated can be monitored by Memory LED (yellow) for 50 min. after alarm output. Memory LED will be off automatically after 3 min. of blinking and 47 min. of lighting on.

Setting	Memory LED
<input checked="" type="checkbox"/> ON 2	YES (AUTO)
<input type="checkbox"/> OFF 2	NO

In case that the sensor initiates alarm again while its memory LED is lighting, LED continues to light on for further 47 min. after that. (re-trigger action)

To reset the sensor LED which is blinking or lighting on, Detach sensor unit from base unit and attach it again, or put off power and on again. (Power on reset)

### Detection timer Selector No.3 and 4

This product alarms when the flame continues for the set time of detection timer or more.

The following 4-settings are available, so set it according to the application.

Setting	Detection timer set time	Application and installation
<input type="checkbox"/> OFF 3 <input type="checkbox"/> OFF 4	0.2sec.	●For the quick detection of the flame of lighter / match at no smoking zone.
<input type="checkbox"/> OFF 3 <input checked="" type="checkbox"/> ON 4	1sec.	●When above setting is not stable.
<input checked="" type="checkbox"/> ON 3 <input type="checkbox"/> OFF 4	6sec.	●For the detection of the fire at smoking zone
<input checked="" type="checkbox"/> ON 3 <input checked="" type="checkbox"/> ON 4	30sec.	●At the window etc. which is subject to reflection of sunlights.

※ When the ultraviolet rays of a flame is weak (it is related to size of flame and distance to sensor), alarm initiation may be delayed beyond the set time.

※ The ultraviolet rays are not visible, and may be detected from unexpected object.

When the sensor's operation is not stable (it detects something but not a flame) and its cause can not be identified, set detection time longer by one step and see the course.

### Factory setting

Alarm sound : ON  
Alarm memory : AUTO  
Detection timer : 0.2 sec.

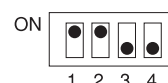

# 7 DETECTION AREA

## 1. DETECTION AREA

●Detection area spreads out in front of the sensor at approx. 120° conically.

●The size of detection area is in proportion to the size of flame and the time of flaming.  
The bigger flame becomes or the longer flame continues, the bigger detection area becomes.  
When small flame such like lighter's is the object to be detected, confirm detection area.

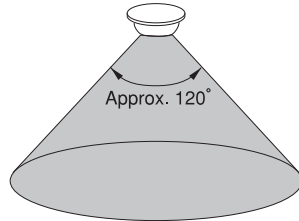

- Condition of detection area  
Detection timer : 0.2sec.  
Origin of flame : Gas lighter  
Size of flame : Approx. 2.75" (7cm)

### Detection area

Front view : Ceiling mount  
Top view : Wall mount

Side view : Ceiling / wall mount

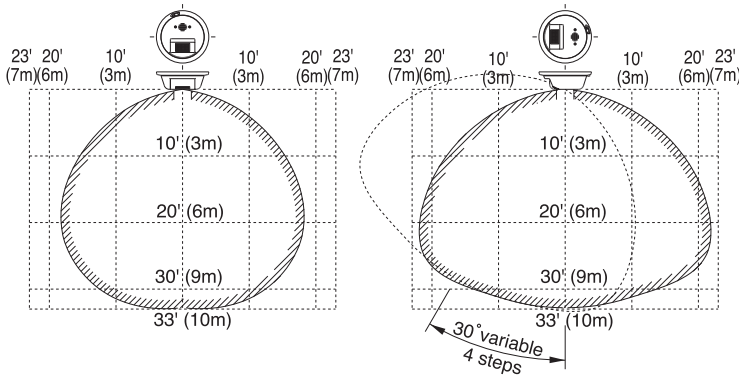

## 2. AREA ADJUSTMENT

●When improper area setting is found out by operation check, adjust area setting.

◁ Adjustment range ▷

Horizontal 25° .....By base unit  
Vertical 30° (4 steps) .....By sensor head

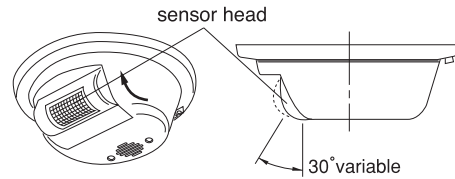

\* Sensor installation surface can be covered by the most forward area setting.

After the adjustment, detach the sensor unit. Fix the sensor head by turning Area locking screw to right, and attach it again.

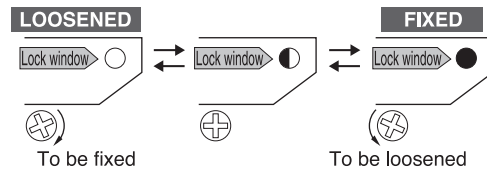

Area locking screw have to be turned with a big cross driver until the inside of Lock window changes to complete black (FIXED : turn to right) or white (LOOSENED : turn to left).

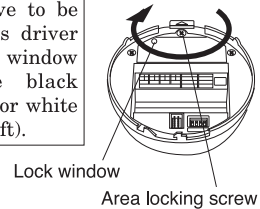

# 8 OPERATION CHECK

1. Turn power on.
2. Ignite a lighter etc. within detection area for more than the set time.
3. After the set time, an alarm output is issued, buzzer sounds intermittently and LED blinks. (Alarm action)
4. 2 sec. after the flame goes off, alarm output ends. 10sec. after the flame goes off, other alarm actions ends. (Check the alarm output by connecting a device such like bell / siren.)



Do not use a lighter in no fire zone because it is dangerous. In such case, operation test have to be done in other place with sensor only.

# 9 TROUBLESHOOTING

Solve possible problems according to the following table .

If normal operations can not be restored by these corrective actions, contact either the dealer from whom you bought the unit or TAKEX.

Trouble	Check	Corrective action
Completely inactive	●No power supply (Broken wire or improper wire) ●Low voltage (When power supply wired)	●Correct power supply or replace broken wire
	●Interrupting rays objects in front of detection area (Glass, transparent resin are interrupting rays objects)	●Remove the interrupting rays object
	●Sensor inside is wet by condensation etc.	●Dry out sensor inside, and remove the cause of the wet
Sometimes inactive	●Improper area setting	●Relocate the sensor to appropriate position
	●Detection window is soiled with dust	●Remove the dust and soil
	●Low voltage	●Correct power supply
Activated without flame	●Large electrical noise source such as a radio station or high-voltage wire nearby	●Relocate the sensor
	●Unexpected ultraviolet rays nearby (Ref : 2, ATTENTION)	●Remove the origin of the ultraviolet rays, interrupt ultraviolet rays, or relocate the sensor
	●Sensor inside is wet by condensation etc.	●Dry out sensor inside, and remove the cause of wet
The alarm LED and buzzer works but the connected devices are inactive	●Poor contact output connection or broken wire	●Check the wiring or connection
	●The connected unit's trouble	●Check the connected unit

### Maintenance

- When the sensor is soiled, clean the cover with a soft cloth moistened with a small amount of cleaning solution. Do not use chemicals such as thinners or alcohol.
- Check operation once a week. Do not fail to check operation whenever a furniture in the place is moved.

When detector elements are stained, spray alcohol to the elements and remove the stain. Do not use such chemicals as mild detergent, thinner or benzene to clean the detector elements. When housing is stained, clean it with a soft cloth.

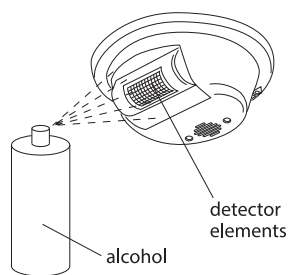

# 11 EXTERNAL DIMENSIONS

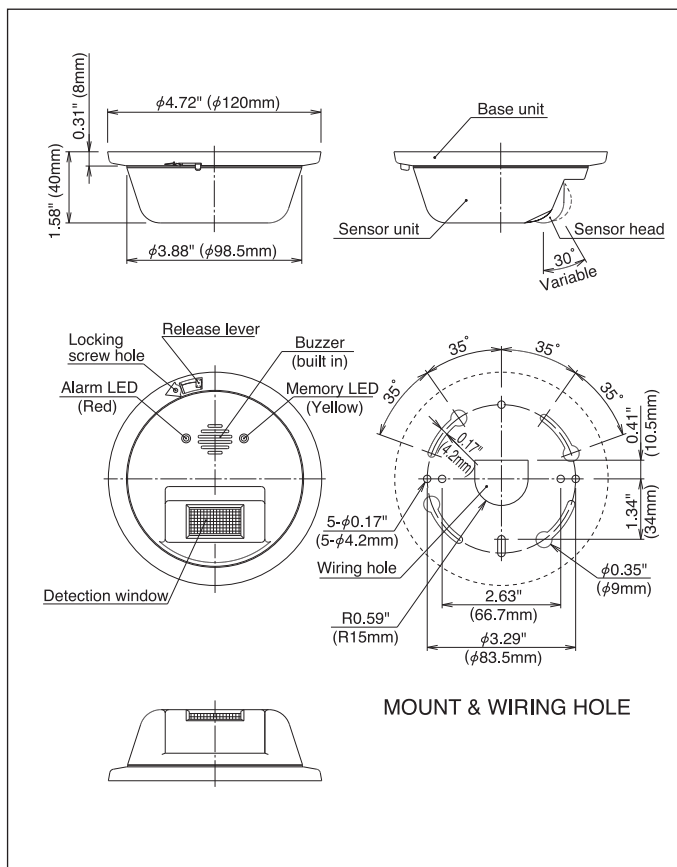

# 10 SPECIFICATIONS

Product name	FLAME SENSOR
Model No.	FS-2000E
Detection system	Ultraviolet rays detection (Detected wave length 185 to 260nm)
Detection area	Distance 33ft.(10m) [2.75"(7cm)lighter flame, in front]
	Angle Approx. 120° conically
	Adjustment range Horizontal 25° by base unit Vertical 30° (4 steps) by sensor head
Sensitivity adjustment	Detection timer 4 steps (0,2 sec., 1 sec., 6sec., and 30 sec.)
Power supply	10V to 30VDC (non-polarity)
Power consumption	Stand by : 25mA or less
	Alarm : 75mA or less (alarm sound ON) 40mA or less (alarm sound OFF)
Alarm output	Dry contact relay Form C (alarm : N.C/N.O) Contact action : Off delay (approx. 2 sec.) Contact capacity : 30VDC·0.3A, protective resistance 3.3 ohms
Alarm memory	Auto-reset operation (on/off setting available) Memory LED blinks for 3 min. then light on for 47 min.
LED	Alarm LED (red) : light on for off delay 10 sec. Memory LED (yellow) : light on when memory indicated, blink when power turned on
Alarm sound (buzzer)	Alarm : Sounds intermittently every 0.2 sec. during off delay 10 sec. Volume : 80dB or more at 3.3ft. (1m) ahead (Silent setting is available)
Tamper output	Dry contact N.C Action : open when sensor unit is detached Capacity : 30V · 0.25A
Wiring	Terminals
Ambient temp. range	+14°F to +140°F (-10°C to +60°C) without condensation
Installation	Indoor (ceiling or wall mount)
Weight	Approx. 150g (5.25oz)
External dimensions	φ 4.72" (120mm)×H 1.58" (40mm)
Appearance	ABS resin (white)
Accessories	● Tapping screw φ 4×25, 2 pcs. ● Sensor locking screw φ 3×6, 1 pce.
Optional	Ceiling mount attachment (BCW-401)

## OPTIONALS

- ◎Ceiling/wall mount attachment (variable attachment)

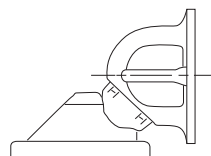

[BCW-401]

For angle adjustment more than horizontal 25° or vertical 30°.

## Limited Warranty :

TAKEX products are warranted to be free from defects in material and workmanship for 12 months from original date of shipment. Our warranty does not cover damage or failure caused by natural disasters, abuse, misuse, abnormal usage, faulty installation, improper maintenance or any repairs other than those provided by TAKEX. All implied warranties with respect to TAKEX, including implied warranties for merchantability and implied warranties for fitness, are limited in duration to 12 months from original date of shipment. During the Warranty Period, TAKEX will repair or replace, at its sole option, free of charge, any defective parts returned prepaid. Please provide the model number of the products, original date of shipment and nature of difficulty being experienced. There will be charges rendered for product repairs made after our Warranty Period has expired.

## TAKEK TAKENAKA ENGINEERING CO., LTD.

In Japan  
**Takenaka Engineering Co., Ltd.**  
 83-1, Gojo-sotokan,  
 Higashino, Yamashina-ku,  
 Kyoto 607-8156, Japan  
 Tel : 81-75-501-6651  
 Fax : 81-75-593-3816  
<http://www.takex-eng.co.jp/>

In the U.S.  
**Takex America Inc.**  
 3350, Montgomery Drive,  
 Santa Clara,  
 CA 95054, U.S.A  
 Tel : 408-747-0100  
 Fax : 408-734-1100  
<http://www.takex.com>

In Australia  
**Takex America Inc.**  
 4/15 Howleys Road, Notting Hill,  
 VIC, 3168  
 Tel : +61 (03) 9544-2477  
 Fax : +61 (03) 9543-2342

In the U.K.  
**Takex Europe Ltd.**  
 Takex House, Aviary Court, Wade Road,  
 Basingstoke, Hampshire. RG24 8PE, U.K.  
 Tel : (+44) 01256-475555  
 Fax : (+44) 01256-466268  
<http://www.takexurope.com>